

PVC CARD

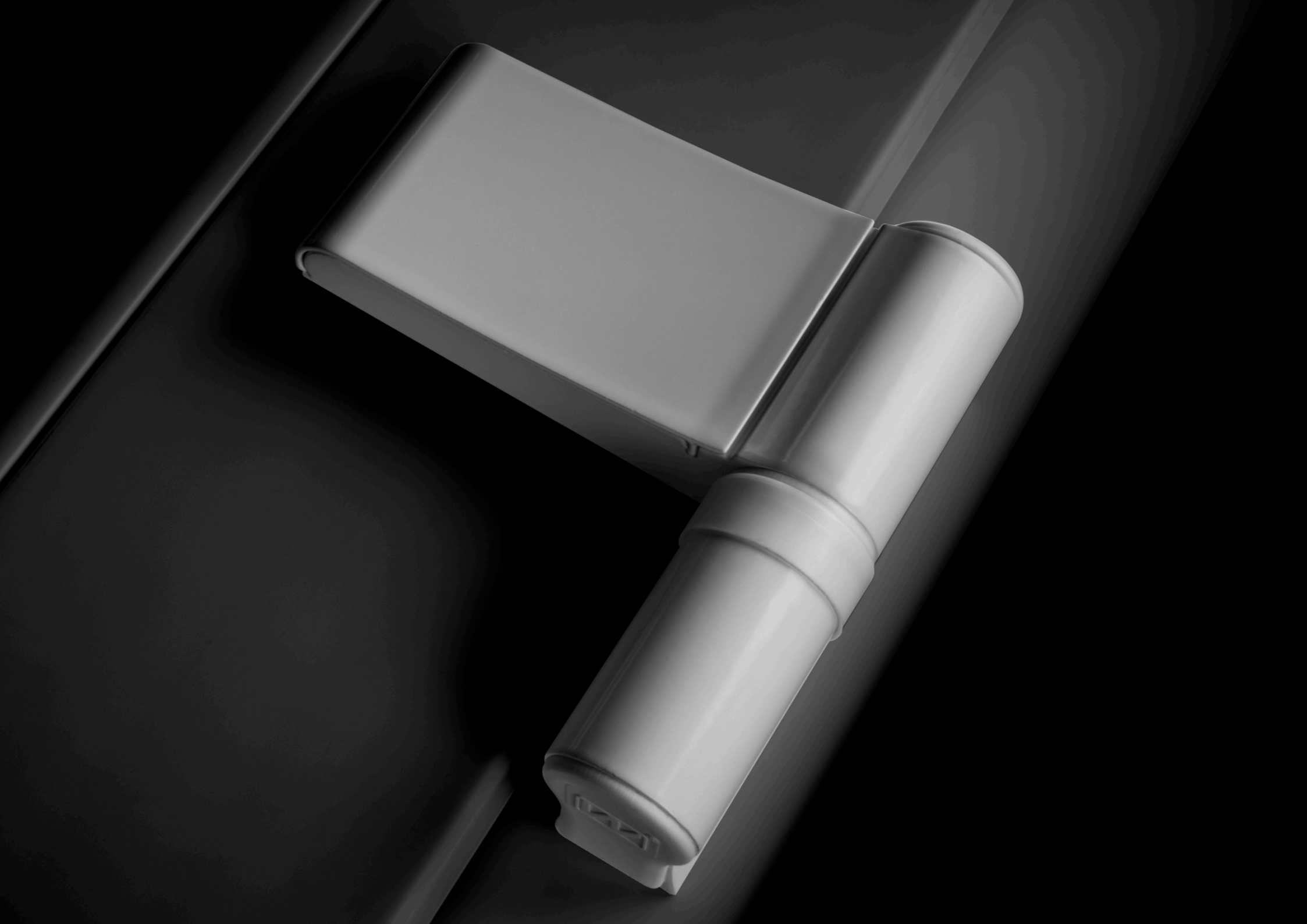







- 7016
- 7021
- 7024
- 9005
- 8077
- 8019
- 8017
- 8003
- 9001
- 1036W
- 9010
- 9016
- 7035
- 9006
- ANODE NATURAL
- INOX COATING
- RAL
- GOLDEN ELECTROPOLER
- GOLD W3
- GOLD W4
- GOLDEN OAK
- WALNUT

- BLACK PLASTIC
- WHITE PLASTIC

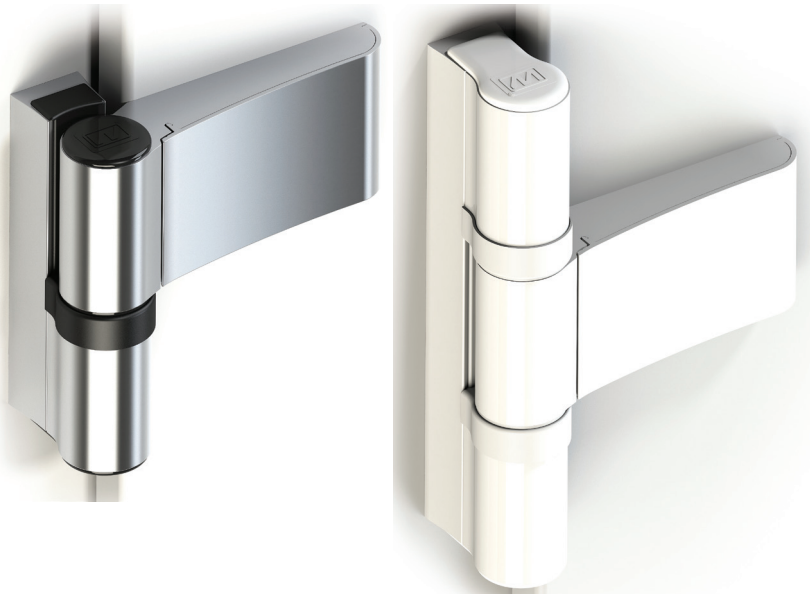

AXL HINGE ADJUSTMENT

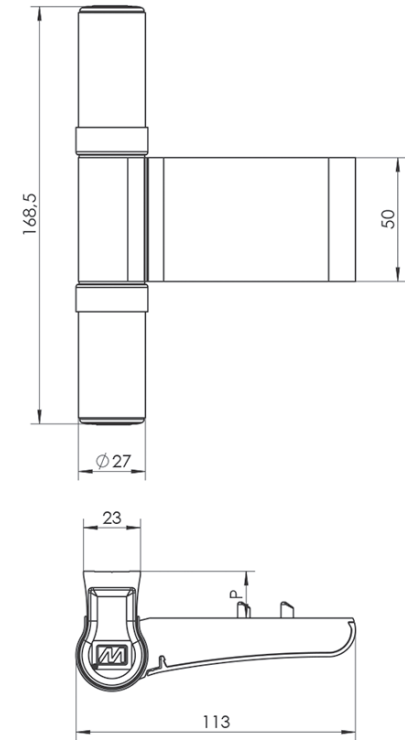
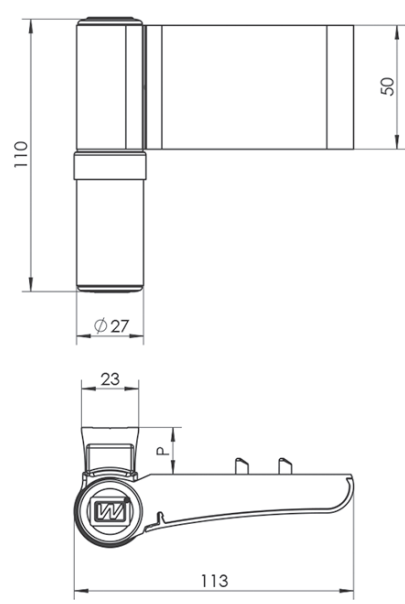
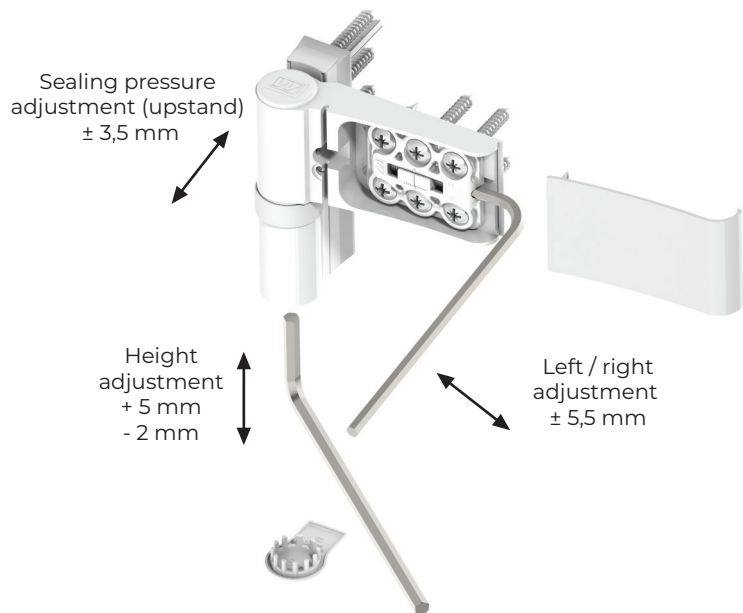

P – upstand in „0” position:
 AXL 19... – 19mm
 AXL 22... – 22mm
 AXL 24... – 24mm



AXL HINGE CLASSIFICATION
 EN 1935:2002 + EN 1935:2002/AC:2003

for use in emergency exit doors

4/4	7/7	7/7	0/1	1/1	4/4	1/1	14/14



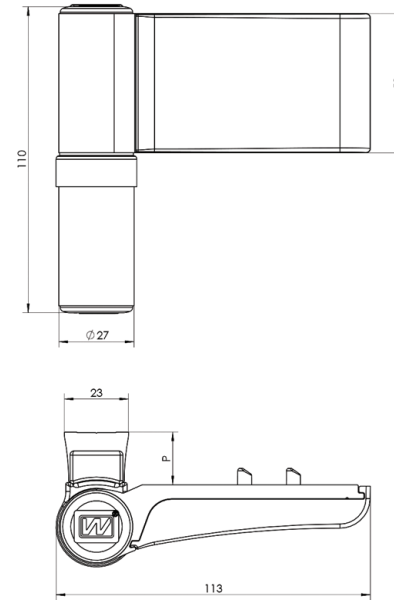

EXL HINGE ADJUSTMENT

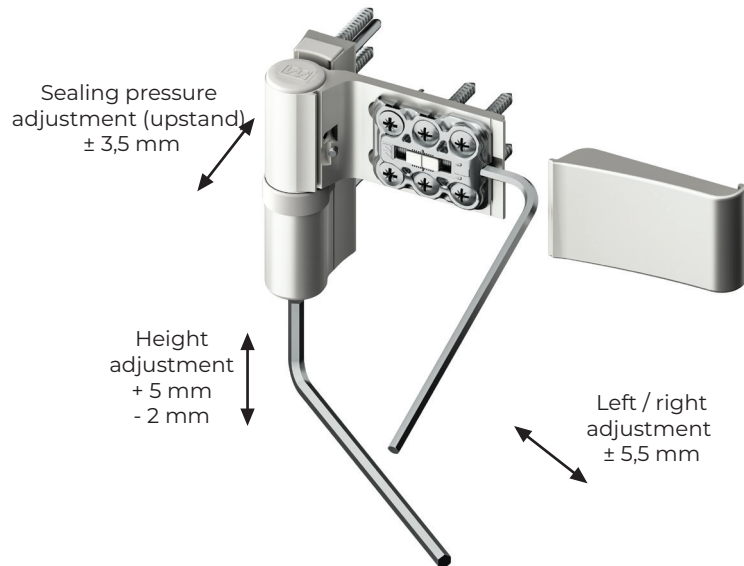

P – upstand in „0“ position:
EXL 19... – 19mm
EXL 22... – 22mm
EXL 24... – 24mm

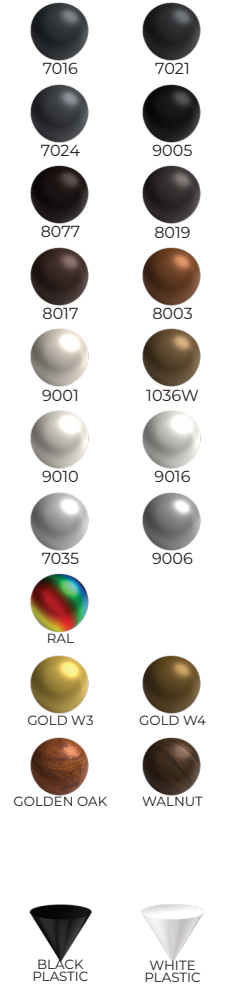



Private building



Public building



Door closer



2-wing hinge



3-wing hinge

		W	S	800	900	1000	1100	1200	1300	1400
 3x 	2000	180	180	170	155	145	140	130	125	
	2100				165	150	145	135	130	
	2200				175	160	150	140	135	
	2300			180	180	170	160	150	140	
	2400						175	165	155	145
	2500			180	180	170	160	150		
	2600							175	165	155
	2700			180	180	175	165	165		
	2800							170		
	2900			180	180	175	165	170		
	3000							175	180	

		W	S	800	900	1000	1100	1200	1300	1400	
 3x 	2000	210	210	195	180	170	155	140	130		
	2100				200	190	175	160	150	135	
	2200			210	210	200	185	170	155	140	
	2300						195	180	165	150	
	2400			210	210	205	190	175	160		
	2500						200	185	170		
	2600			210	210	195	180	165	150		
	2700						205	190			
	2800			210	210	200	185	170			
	2900						195	180			
	3000			210	210	205	190				
	3000						200	105	210		

		W	S	800	900	1000	1100	1200	1300	1400	
 3x 4x 	2000	140	140	130	115	105	110	100	95		
	2100				135	125	110	115	105	100	
	2200				140	135	120	120	110	105	
	2300			150	150	140	130	120	110		
	2400						145	135	125	115	
	2500			150	150	140	130	120			
	2600						145	135	125		
	2700			150	150	145	135	125			
	2800						140				
	2900			150	150	145	135	125			
	3000						140	150	150		

		W	S	800	900	1000	1100	1200	1300	1400	
 3x 4x 	2000	170	170	155	140	130	125	110	100		
	2100				160	150	135	130	120	105	
	2200				170	160	145	140	125	110	
	2300			180	180	165	150	135	120		
	2400						175	160	145	130	
	2500			180	180	170	155	140			
	2600						165	150			
	2700			180	180	175	160	145	130		
	2800						165	150			
	2900			180	180	170	155	140			
	3000						175	160			

If the distance between hinges in the middle of a door exceeds 1500mm, we suggest using additional hinge which caulks the door.





Private building



Public building



Door closer



2-wing hinge



3-wing hinge

	W	S	800	900	1000	1100	1200	1300	1400
 3x 	2000	150	150	140	125	115	110	100	95
	2100			145	135	120	115	105	100
	2200			145	130	120	110	105	
	2300		150	150	140	130	120	110	
	2400				145	135	125	115	
	2500		150	150	150	140	130	120	
	2600					145	135	125	
	2700					145	135	125	
	2800		150	150	150	150	140	130	120
	2900						145	135	125
	3000						150	140	130

	W	S	800	900	1000	1100	1200	1300	1400
 3x 	2000	180	180	165	150	140	125	110	100
	2100			170	160	145	130	120	105
	2200			170	155	140	125	110	
	2300		180	180	180	165	150	135	120
	2400					175	160	145	130
	2500		180	180	180	180	170	155	140
	2600						165	150	
	2700						175	160	
	2800		180	180	180	180	180	165	150
	2900							175	160
	3000							180	170



















	W	S	800	900	1000	1100	1200	1300	1400
 3x 4x 	2000	130	130	120	105	95	90	80	75
	2100			125	115	100	95	85	80
	2200			130	125	110	100	90	85
	2300		130	130	130	120	110	100	90
	2400					125	115	105	95
	2500		130	130	130	130	120	110	100
	2600						125	115	105
	2700						125	115	105
	2800		130	130	130	130	130	120	110
	2900							125	115
	3000							130	120

	W	S	800	900	1000	1100	1200	1300	1400
 3x 4x 	2000	160	160	145	130	120	105	90	80
	2100			150	140	125	110	100	85
	2200			160	150	135	120	105	90
	2300		160	160	160	145	130	115	100
	2400					155	140	125	110
	2500		160	160	160	160	150	135	120
	2600						145	130	
	2700						155	140	
	2800		160	160	160	160	160	145	130
	2900							155	140
	3000							160	155

If the distance between hinges in the middle of a door exceeds 1500mm, we suggest using additional hinge which caulks the door.





-  7016
-  7021
-  7024
-  9005
-  8077
-  8019
-  8017
-  8003
-  9001
-  1036W
-  9010
-  9016
-  7035
-  9006
-  ANODE NATURAL
-  INOX COATING
-  RAL
-  GOLDEN ELECTROPOLER
-  GOLD W3
-  GOLD W4
-  GOLDEN OAK
-  WALNUT



AXM HINGE ADJUSTMENT

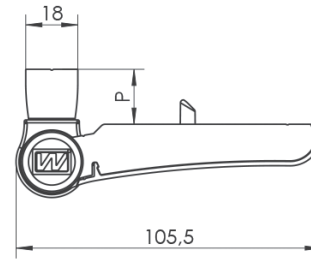
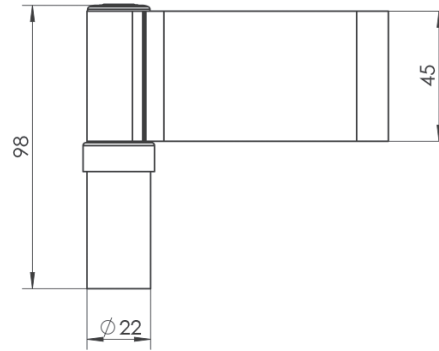
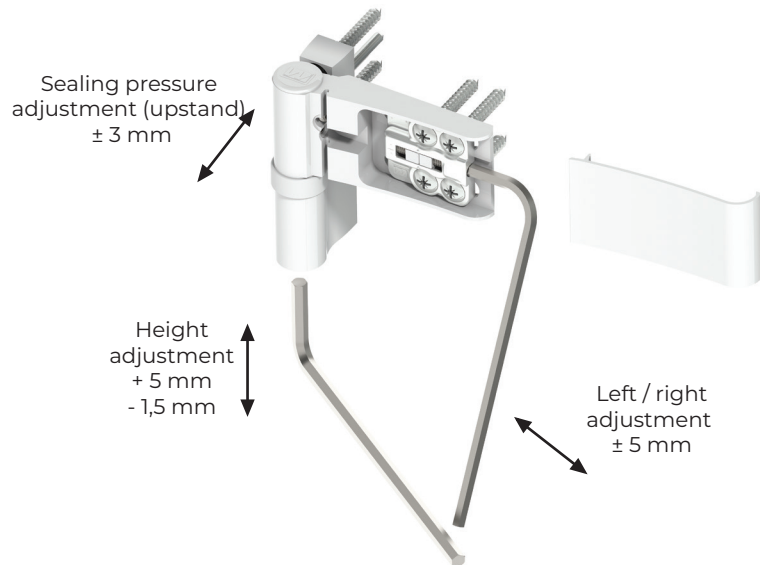

P – upstand in „0“ position:
 AXM 17... – 17mm (14 - 20mm)
 AXM 19... – 19mm (16 - 22mm)
 AXM 21... – 21mm (18 - 24mm)

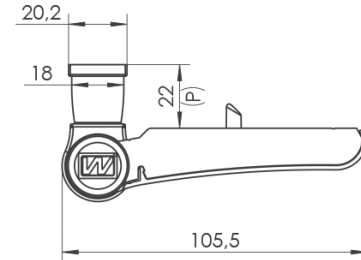
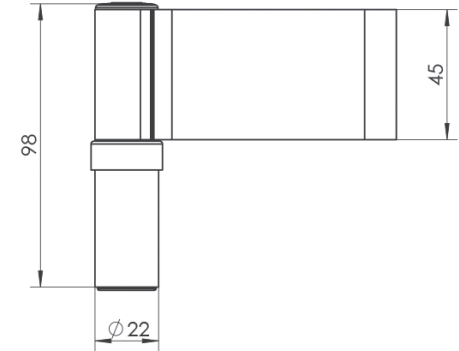

Due to the application the 3mm distance plate, the upstand 20mm, 22mm and 24mm can be achieved.

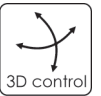

AXM HINGE CLASSIFICATION
 EN 1935:2002 + EN 1935:2002/AC:2003

for use in emergency exit doors

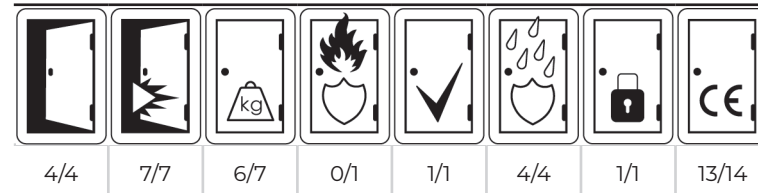

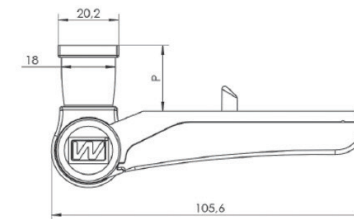
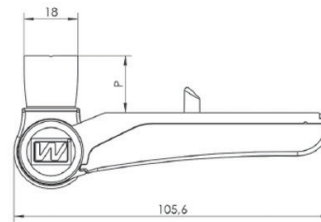
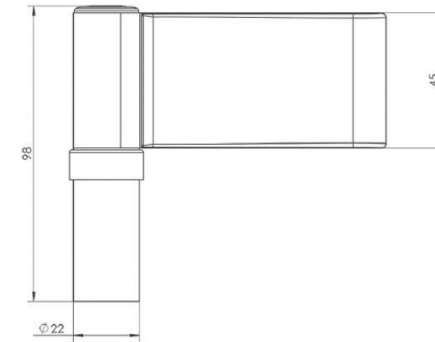
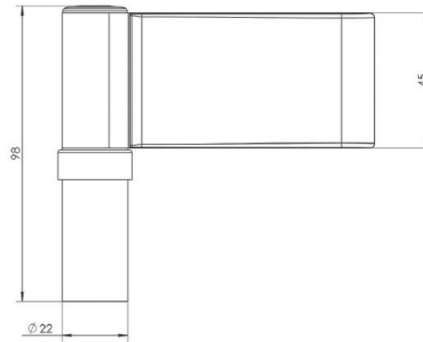

EXM HINGE ADJUSTMENT

P – upstand in „0“ position:
 EXM 17... – 17mm (14 - 20mm)
 EXM 19... – 19mm (16 - 22mm)
 EXM 21... – 21mm (18 - 24mm)

Due to the application the 3mm distance plate, the upstand 20mm, 22mm and 24mm can be achieved.

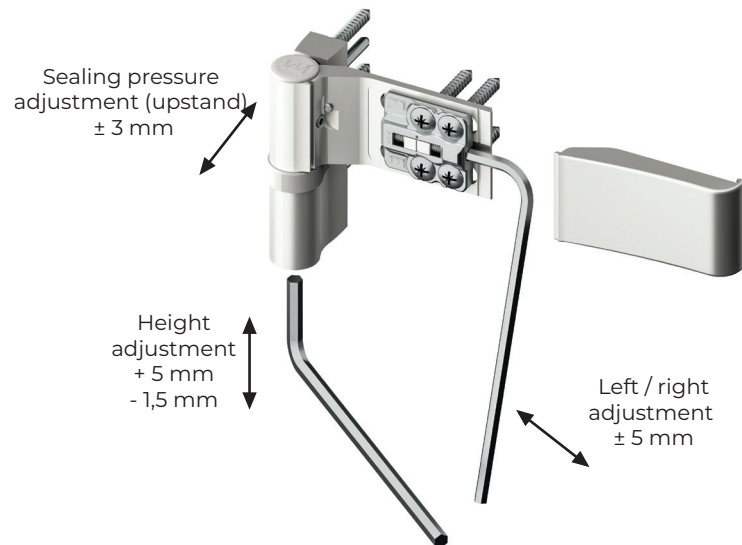

- | | | | |
|--|------------|--|---------|
| | 7016 | | 7021 |
| | 7024 | | 9005 |
| | 8077 | | 8019 |
| | 8017 | | 8003 |
| | 9001 | | 1036W |
| | 9010 | | 9016 |
| | 7035 | | 9006 |
| | RAL | | |
| | GOLD W3 | | GOLD W4 |
| | GOLDEN OAK | | WALNUT |

- | | | | |
|--|---------------|--|---------------|
| | BLACK PLASTIC | | WHITE PLASTIC |
|--|---------------|--|---------------|





Private building



Public building



Door closer



2-wing hinge

		W	S	800	900	1000	1100	1200	1300	1400
 3x	2000	135	135	125	110	100	95	85	80	
	2100			130	120	105	100	90	85	
	2200			130	115	105	95	90		
	2300				125	115	105	95		
	2400			125	110	100				
	2500				115	105				
	2600			120	110					
	2700				130	120				
	2800			135	125					
	2900				130					
	3000				135					

		W	S	800	900	1000	1100	1200	1300	1400
 3x	2000	110	110	100	85	75	70	60	55	
	2100			105	95	80	75	65	60	
	2200			105	80	70	65	60		
	2300				90	80	70	65		
	2400			105	85	75	65	60		
	2500				95	85	75	65		
	2600			105	80	70	65	60		
	2700				90	80	70	65		
	2800			110	85	75	65	60		
	2900				95	85	75	65		
	3000				105	95	85	75	65	60

		W	S	800	900	1000	1100	1200	1300	1400	
 3x 4x	2000	110	110	90	75	65	70	60	55		
	2100			95	85	70	75	65	60		
	2200			100	95	80	80	70	65		
	2300			105	80	80	70	65			
	2400				90	80	70	65			
	2500			105	75	65	60	55			
	2600				85	75	65	60			
	2700			110	75	65	60	55			
	2800				85	75	65	60			
	2900				95	85	75	65	60		
	3000			110	100	90	80	70	60	55	
					105	95	85	75	65	60	

If the distance between hinges in the middle of a door exceeds 1500mm, we suggest using additional hinge which caulks the door.





AXS HINGE ADJUSTMENT

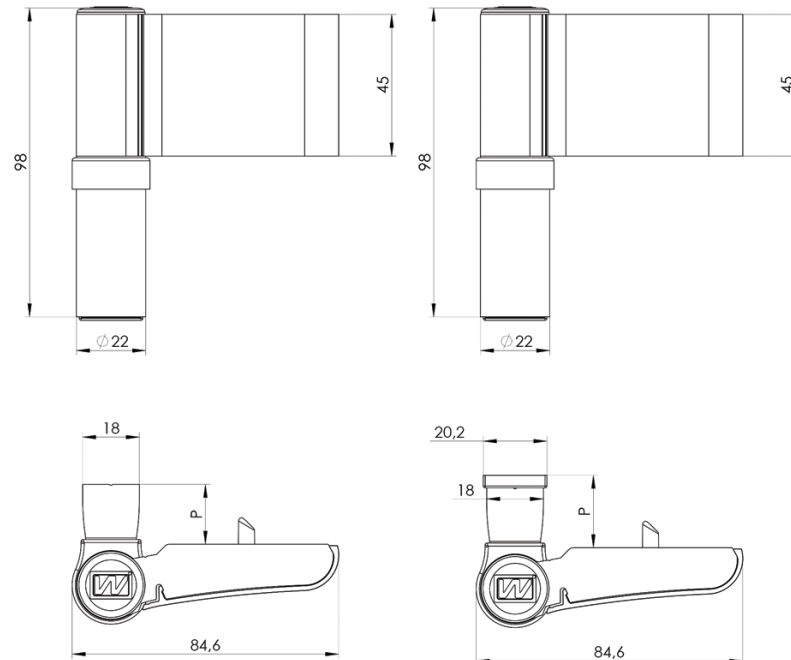
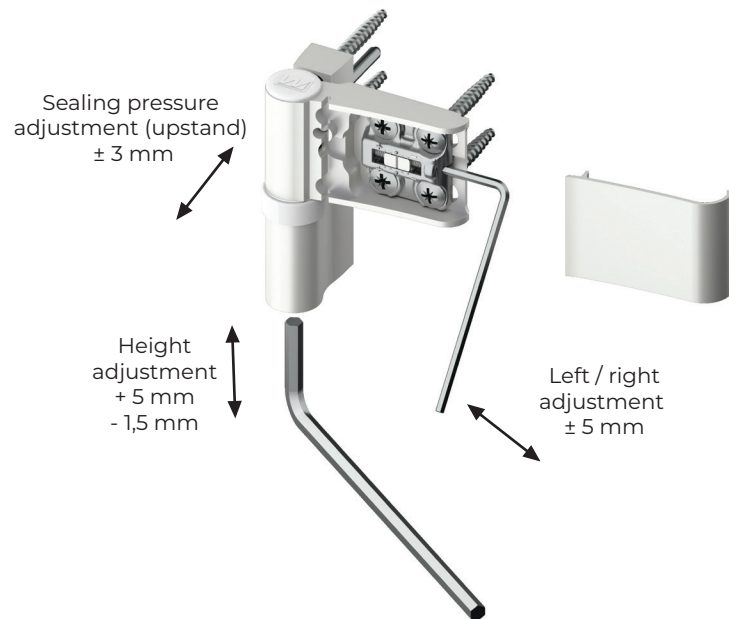

P – upstand in „0“ position:
 AXS 17... – 17mm (14 - 20mm)
 AXS 19... – 19mm (16 - 22mm)
 AXS 21... – 21mm (18 - 24mm)

Due to the application the 3mm distance plate, the upstand 20mm, 22mm and 24mm can be achieved.

- | | | | |
|--|---------------|--|---------------------|
| | 7016 | | 7021 |
| | 7024 | | 9005 |
| | 8077 | | 8019 |
| | 8017 | | 8003 |
| | 9001 | | 1036W |
| | 9010 | | 9016 |
| | 7035 | | 9006 |
| | ANODE NATURAL | | INOX COATING |
| | RAL | | GOLDEN ELECTROPOLER |
| | GOLD W3 | | GOLD W4 |
| | GOLDEN OAK | | WALNUT |





Private building



Public building



Door closer



2-wing hinge

W	S	800	900	1000	1100	1200
		2000	100	90	80	70
2100	110	100	90	80	70	
2200	120	110	100	90	80	
2300	130	120	110	100	90	
2400	130	120				
2500	120	110	110	100	90	
2600						
2700						
2800						
2900						
3000						

W	S	800	900	1000	1100	1200
		2000	135	125	110	100
2100	135	130	120	105	100	
2200	135	135	130	115	105	
2300	135	135	135	125	110	115
2400	135	135				
2500	125	125	125	125	110	
2600						
2700						
2800						
2900						
3000						

W	S	800	900	1000	1100	1200
		2000	100	90	80	70
2100	110	100	90	80	70	
2200	120	110	100	90	80	
2300	130	120	110	100	90	
2400	130	120				
2500	120	110	110	100	90	
2600						
2700						
2800						
2900						
3000						

If the distance between hinges in the middle of a door exceeds 1500mm, we suggest using additional hinge which caulks the door.





AXL / EXL



AXL / EXL

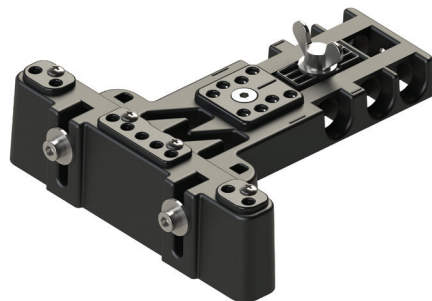

TOOLING IN PROFILE
AXL / EXL 2-wing hinge

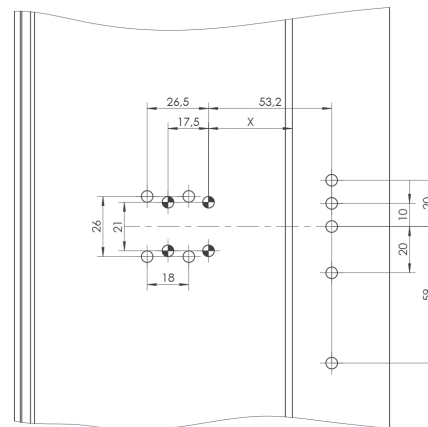

TOOLING IN PROFILE
AXL / EXL 3-wing hinge

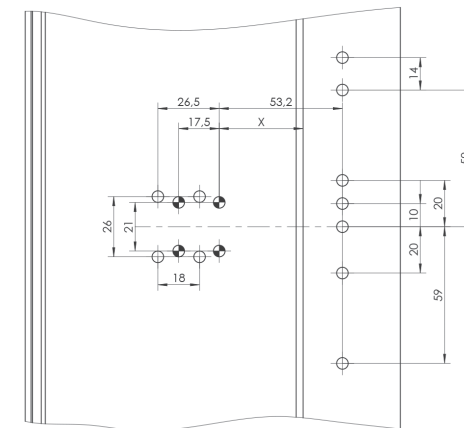

DISTANCE THICKNESS A	VALUE X
2 mm	40 mm
4 mm	38 mm
6 mm	36 mm
8 mm	34 mm



DISTANCE THICKNESS A	VALUE X
4 mm	36 mm
5 mm	35 mm
6 mm	34 mm
7 mm	33 mm
8 mm	32 mm

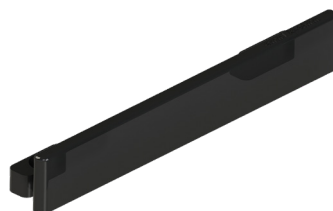
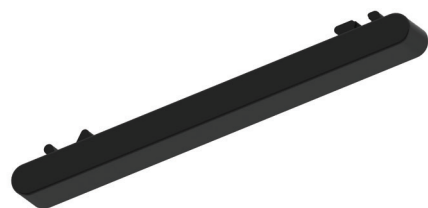
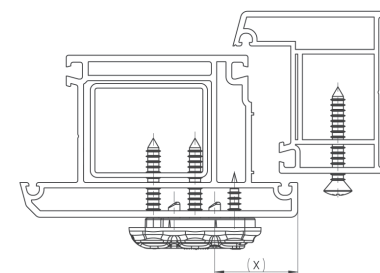

- drilling Ø5 through the steel hardener
- drilling Ø5, depth of drilling - 10mm (usually just through the plastic to hardener)
- X** dimension of drilling distance, settled individually for each system so that the drilling runs completely in the hardener and not behind it. It is also use the settle the templates for drilling the holes in the profile according to suitbale dustances.



AXM / EXM

AXS

TOOLING IN PROFILE
AXM / EXM

TOOLING IN PROFILE
AXS

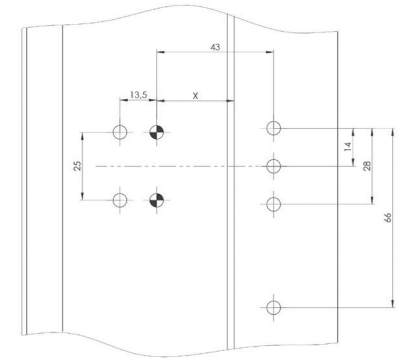
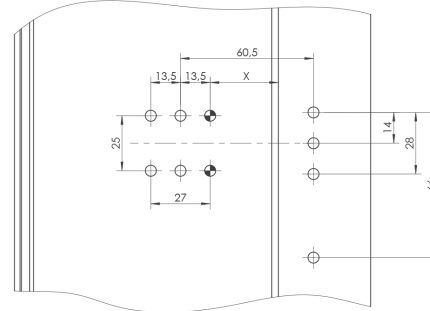
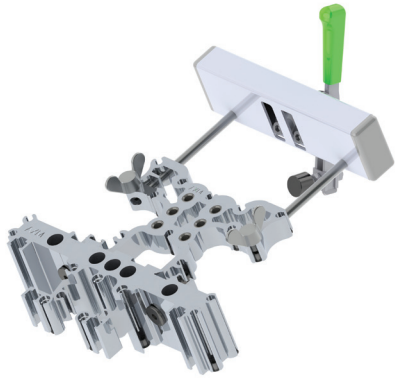

DISTANCE THICKNESS A	VALUE X
2 mm	34 mm
4 mm	32 mm
6 mm	30 mm
8 mm	28 mm

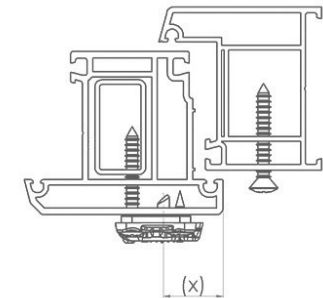
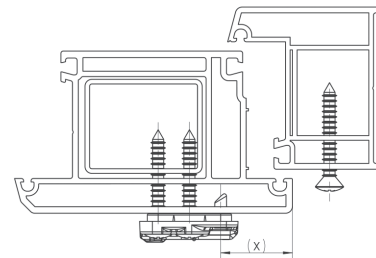

- ⊕ drilling Ø5 through the steel hardener
- ⊖ drilling Ø5, depth of drilling - 10mm (usually just through the plastic to hardener)
- X dimension of drilling distance, settled individually for each system so that the drilling runs completely in the hardener and not behind it. It is also use the settle the templates for drilling the holes in the profile according to suitable distances.



TRIPLE TEMPLATE

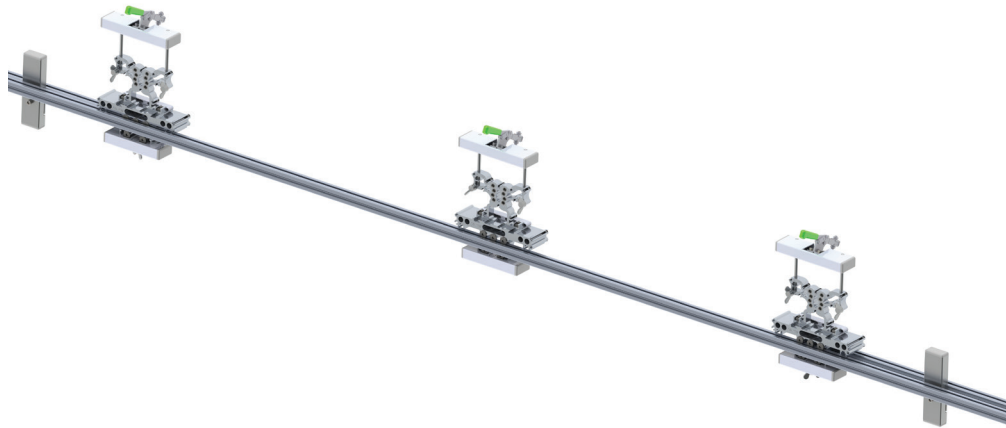

AXL TRIPLE TEMPLATE

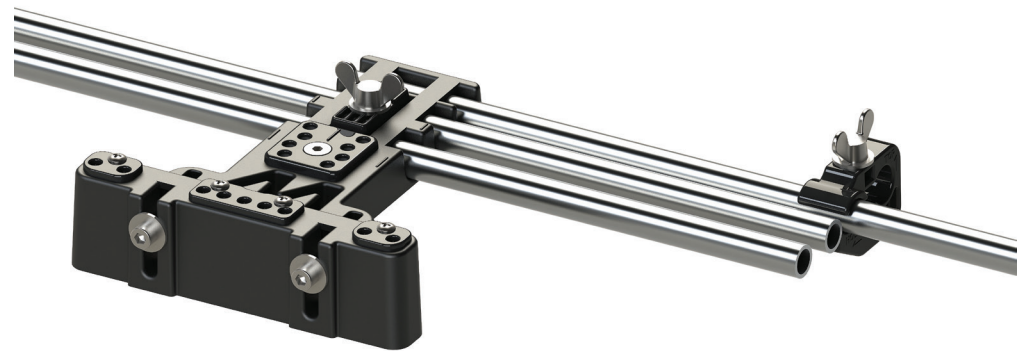
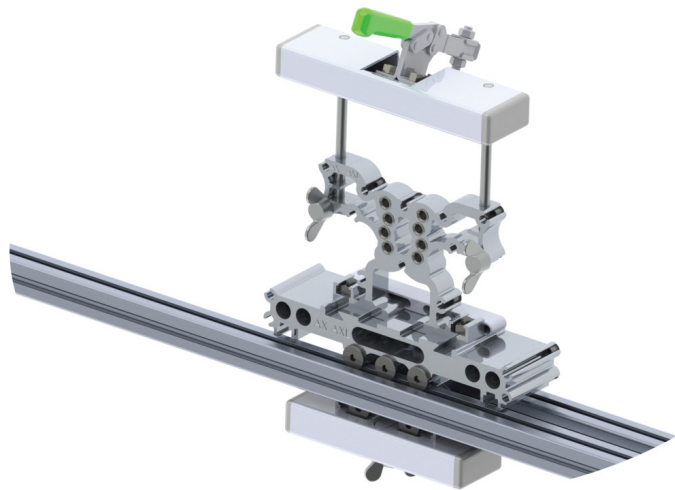

WALA Sp. z o.o.

ul. Parkowa 16
43-365 Wilkowice

www.wala.pl

wala@wala.pl

tel.: +48 827 23 90

kom. +48 725 70 80 30