

# WIRING DIAGRAM

Title: Wiring diagram for door manufacturers/electricians

Document: ekey\_integra\_MACO\_Z-TA\_ekeyCT

ID: 134/462/0/306 Version: 3, 18.08.2015









## NOTICE

This wiring diagram is not subject to updating. Subject to optical and technical modifications, any liability for errors and misprints excluded.

## ⚠ DANGER

Dangerous electric voltage. Only certified electricians are authorised to carry out the electrical installation!

## LEGEND

-  ... Finger scanner *integra*
-  ... Finger scanner *integra BT*
-  ... Finger scanner *arte*
  
-  ... Cable transfer 100 880  
100 881  
101 561
  
-  ... Motorised lock MACO Z-TA Comfort
  
-  ... Control panel *integra*
-  ... Control panel *integra plus*
  
-  ... Adapter cable 101 604
-  ... Cable connection

### CONNECTION TO THE MOTORISED LOCK

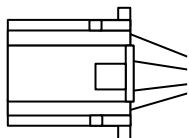

Pin	Colour	Description
1	yellow	floating input
2	green	floating input
3	white	VDC (+)
4	brown	GND (-)

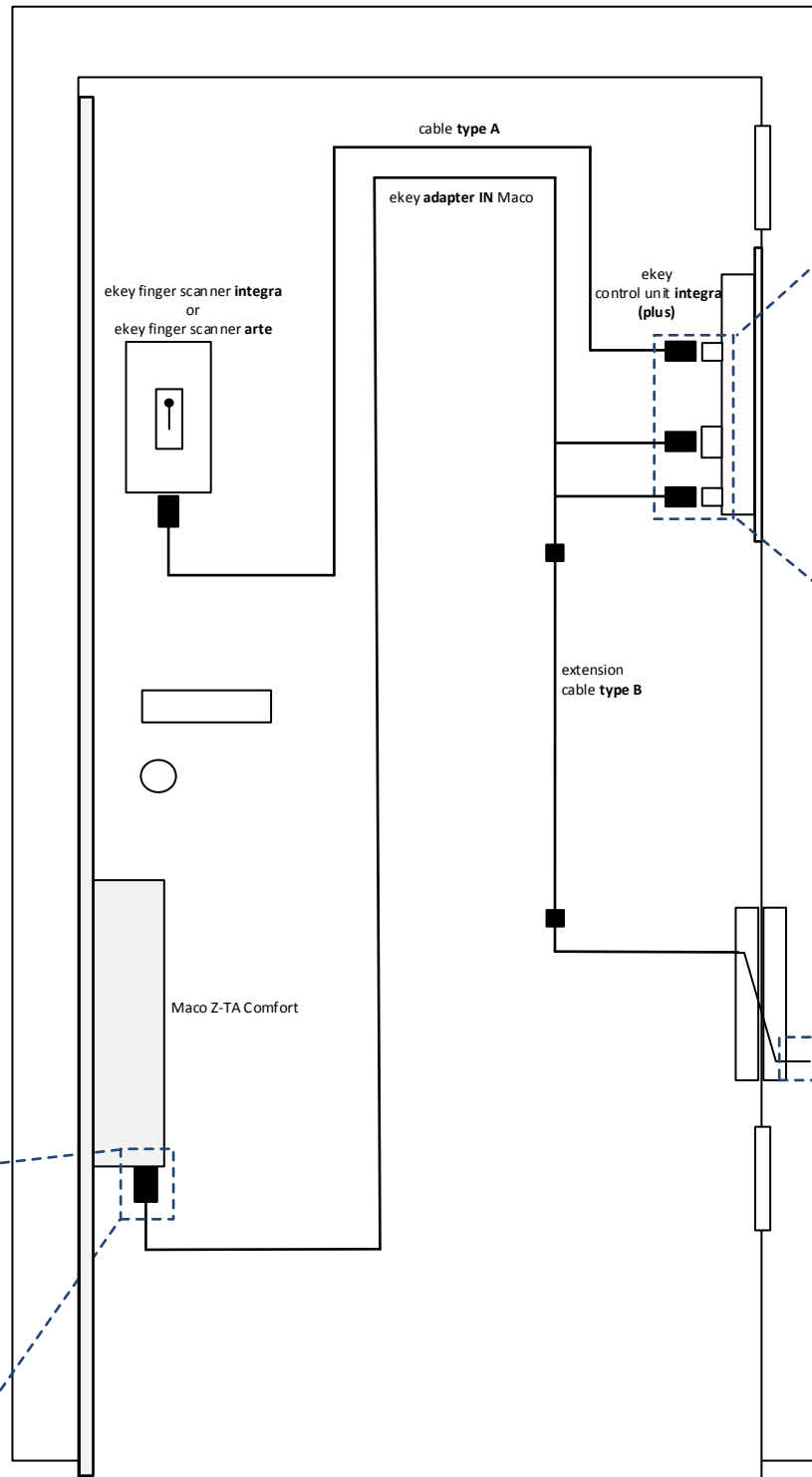

### CONNECTION TO THE CONTROL PANEL

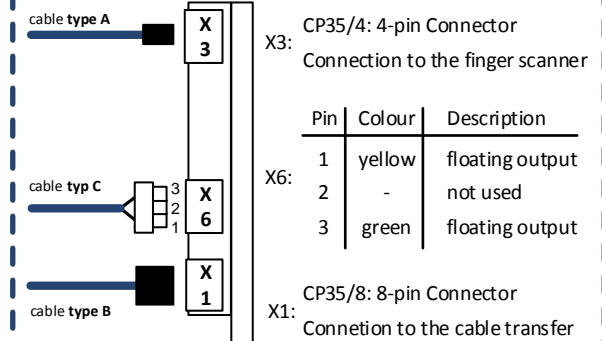

## NOTICE

Operation of the relay 1 has to be set to "floating" by JP1 (Position JP1: 2-3)

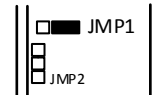

### WIRING DIAGRAM FOR ELECTRICIANS

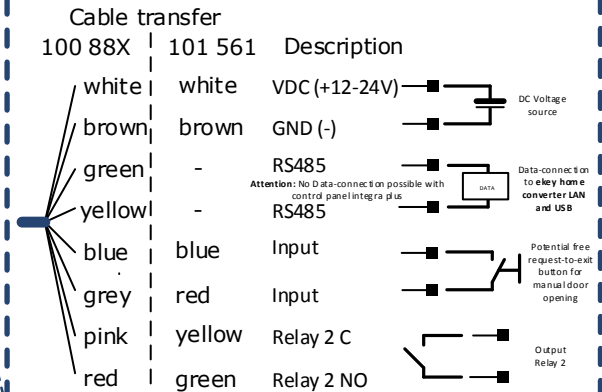

## NOTICE

Each unused core must be insulated separately!