

x 1

x 2 x 2 x 2

MOUNTING SET

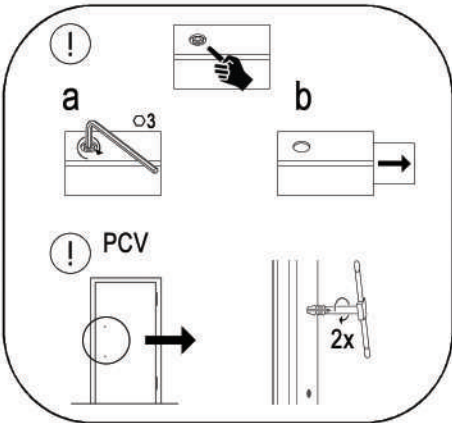
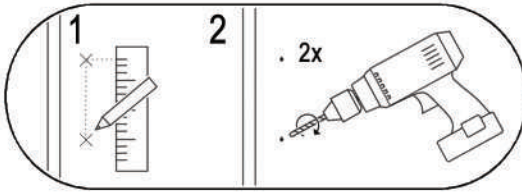
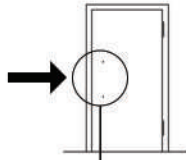

MOUNTING SET

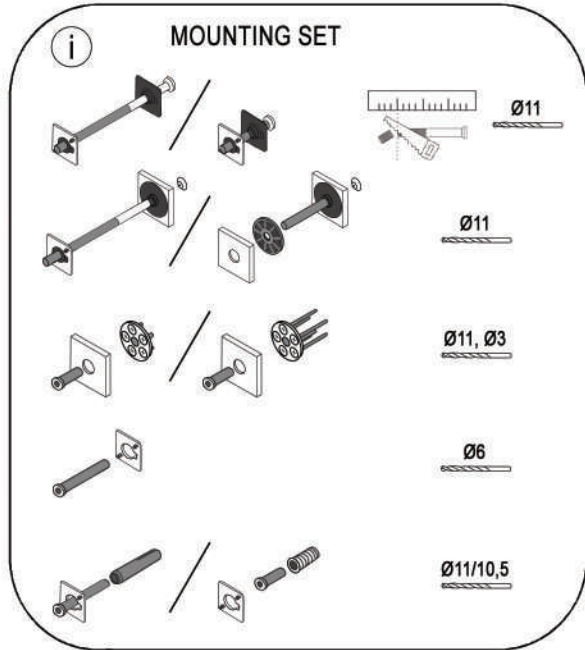

GO TO

- 4-6 (p.1) → 27 (p.2)
- 18 (p.2)
- 12 (p.2)
- 4 (p.1)
- 3 (p.1)

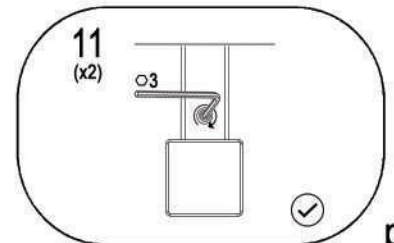
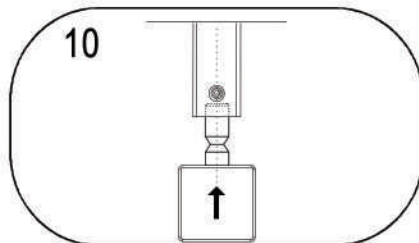
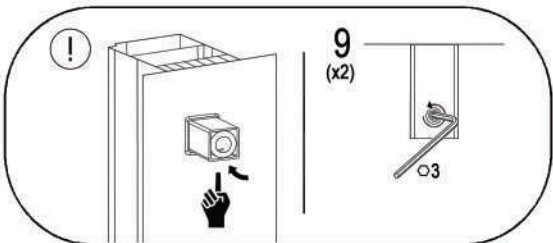
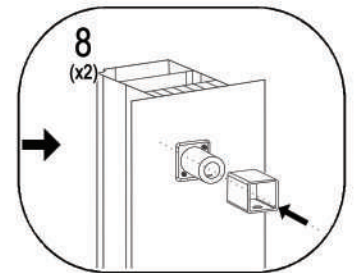
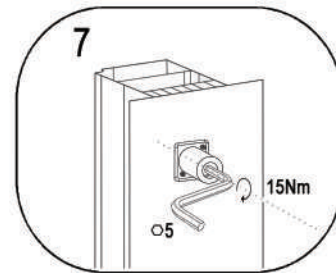
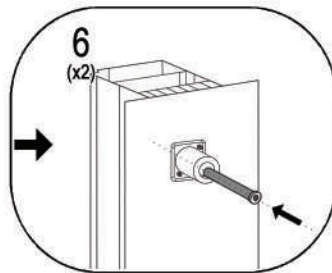
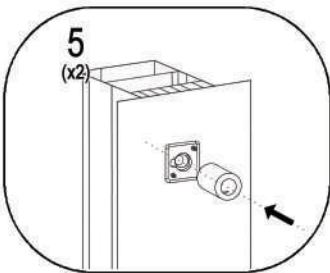
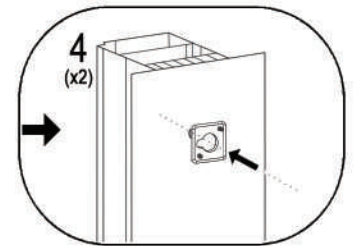
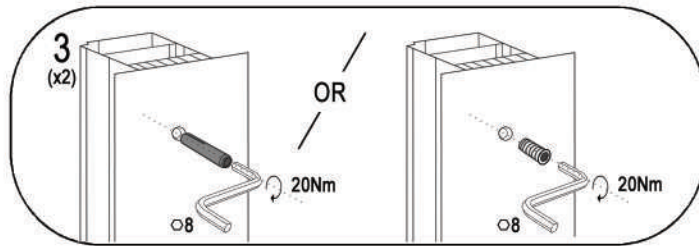

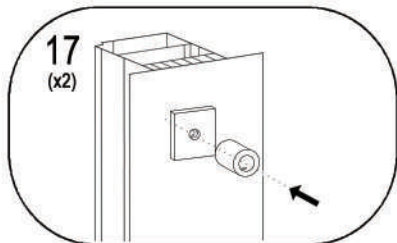
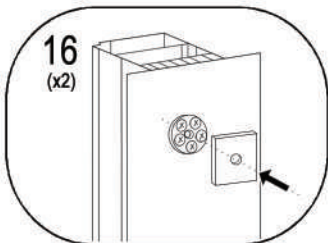
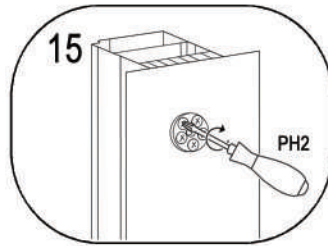
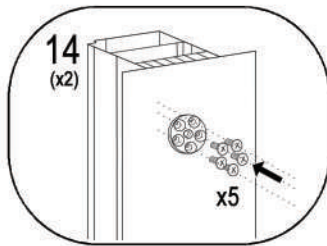
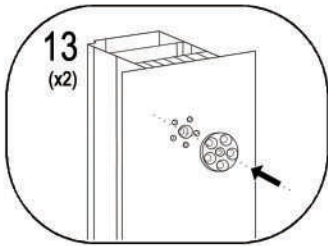
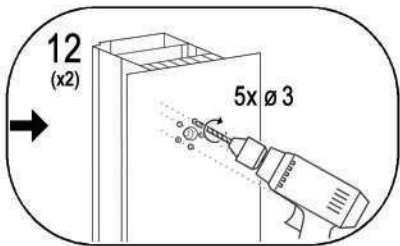

GO TO

→ 6 - 11 (p.1)

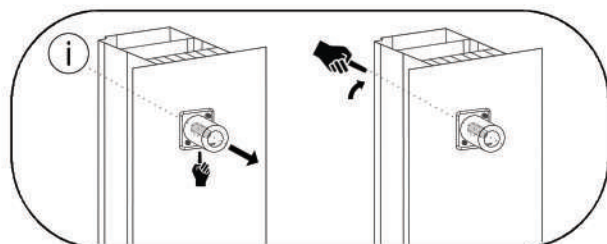
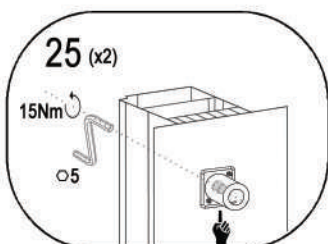
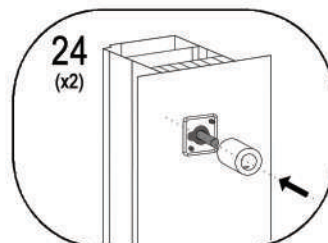
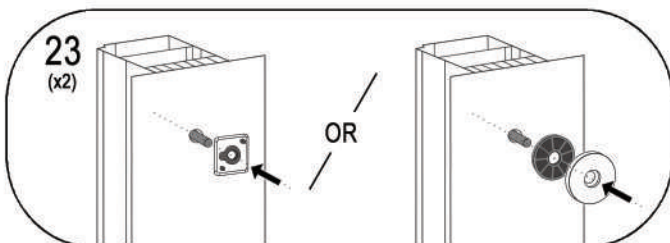
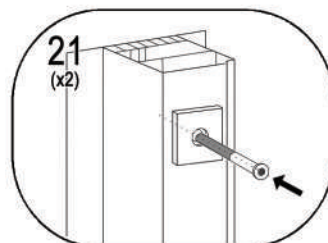
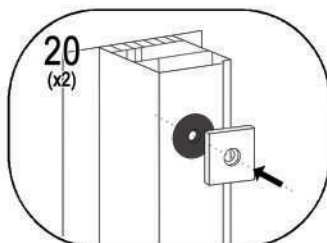
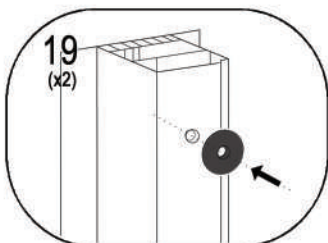
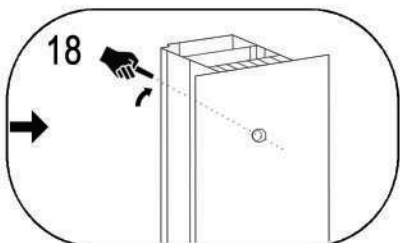

GO TO

→ 8 - 11 (p.1)

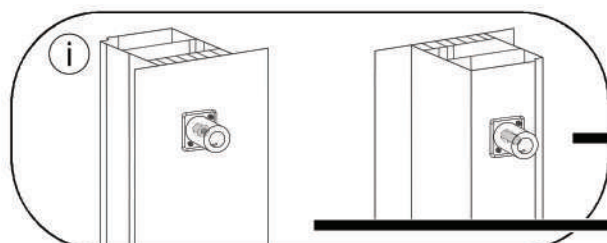
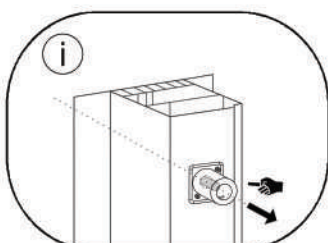
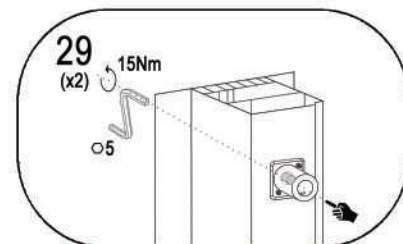
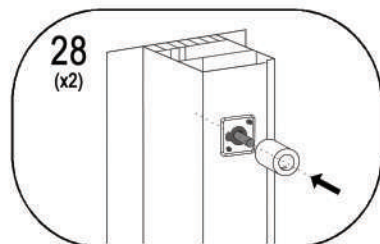
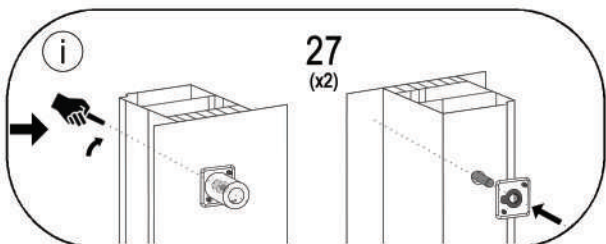

GO TO

→ 8 - 11 (p.1)